

Yukti Model:-263

Super Big Capacity Commercial Industrial Dehydrator Dryer Machine

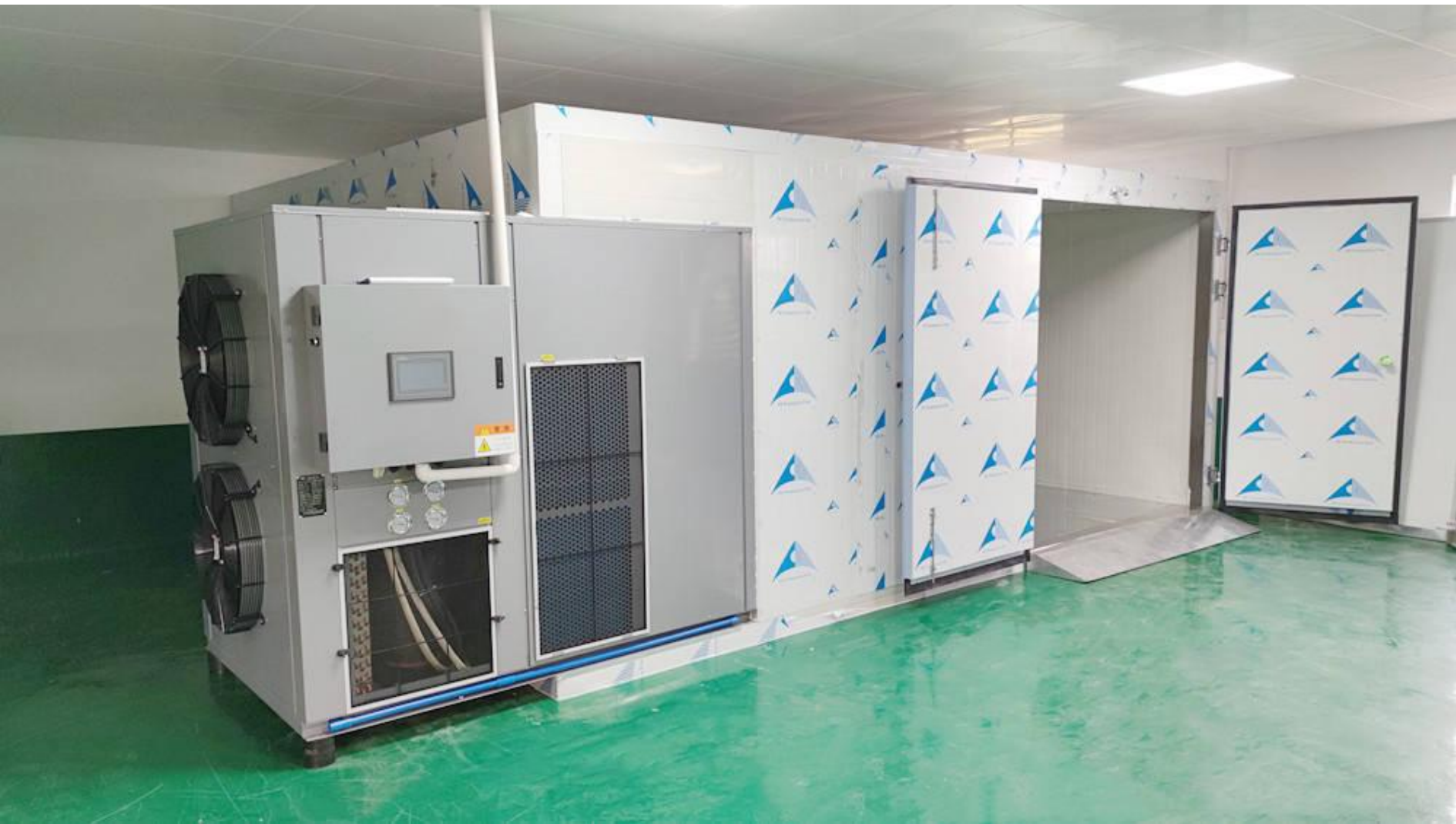











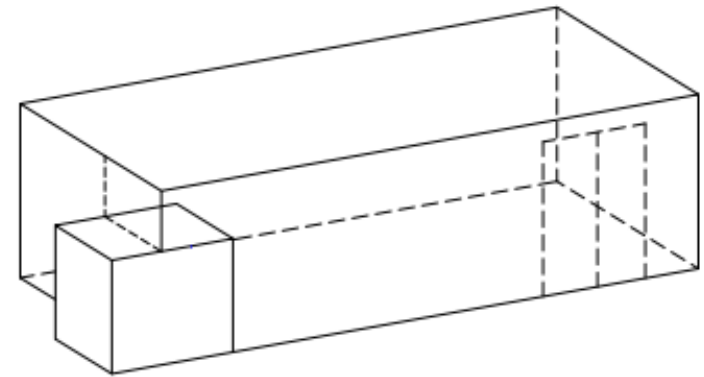
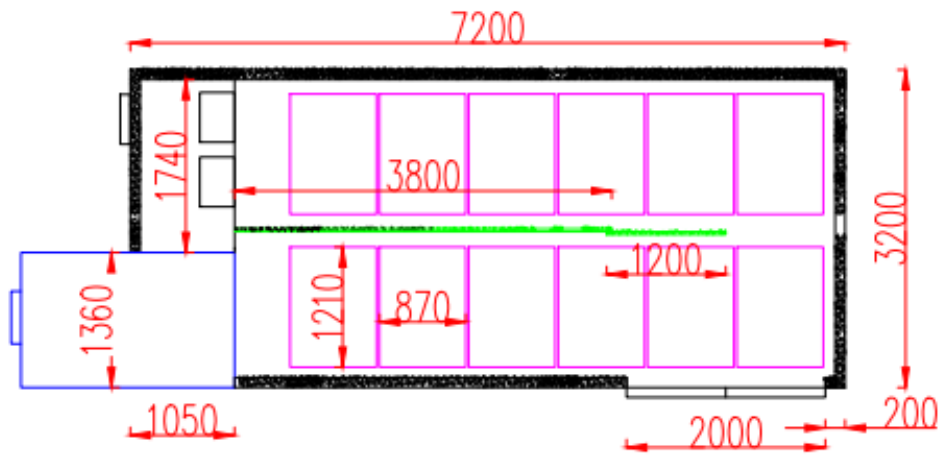

Vertical View

3D View

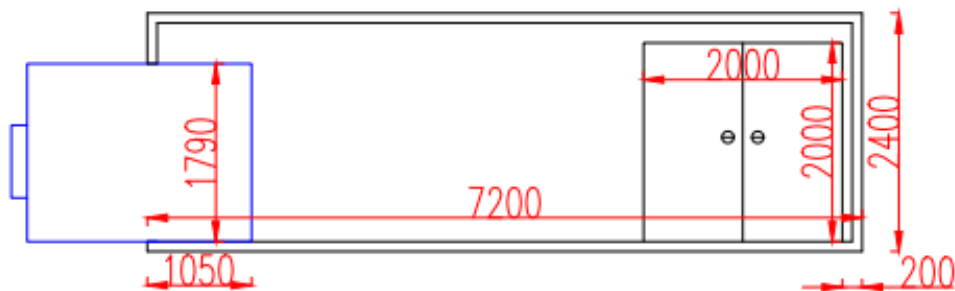

Front View

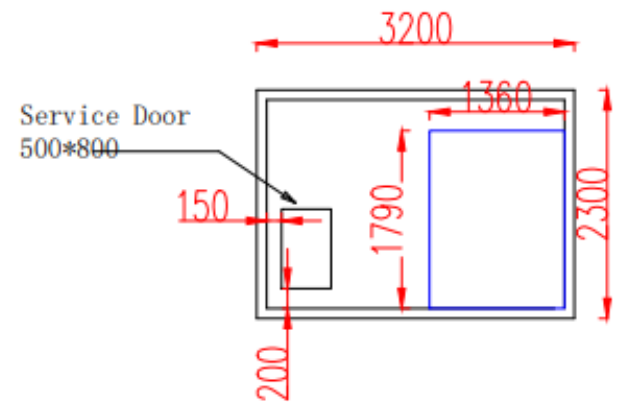

Left View

Remark:

1. PU insulation Panel, total 10cm Thickness, 0.326mm thickness power coated steel as metal sheet.
2. Drying Chamber: L7.2m*W3.2m*H2.3m
3. Sealing Door: 2m*1.9m.

Working Principle

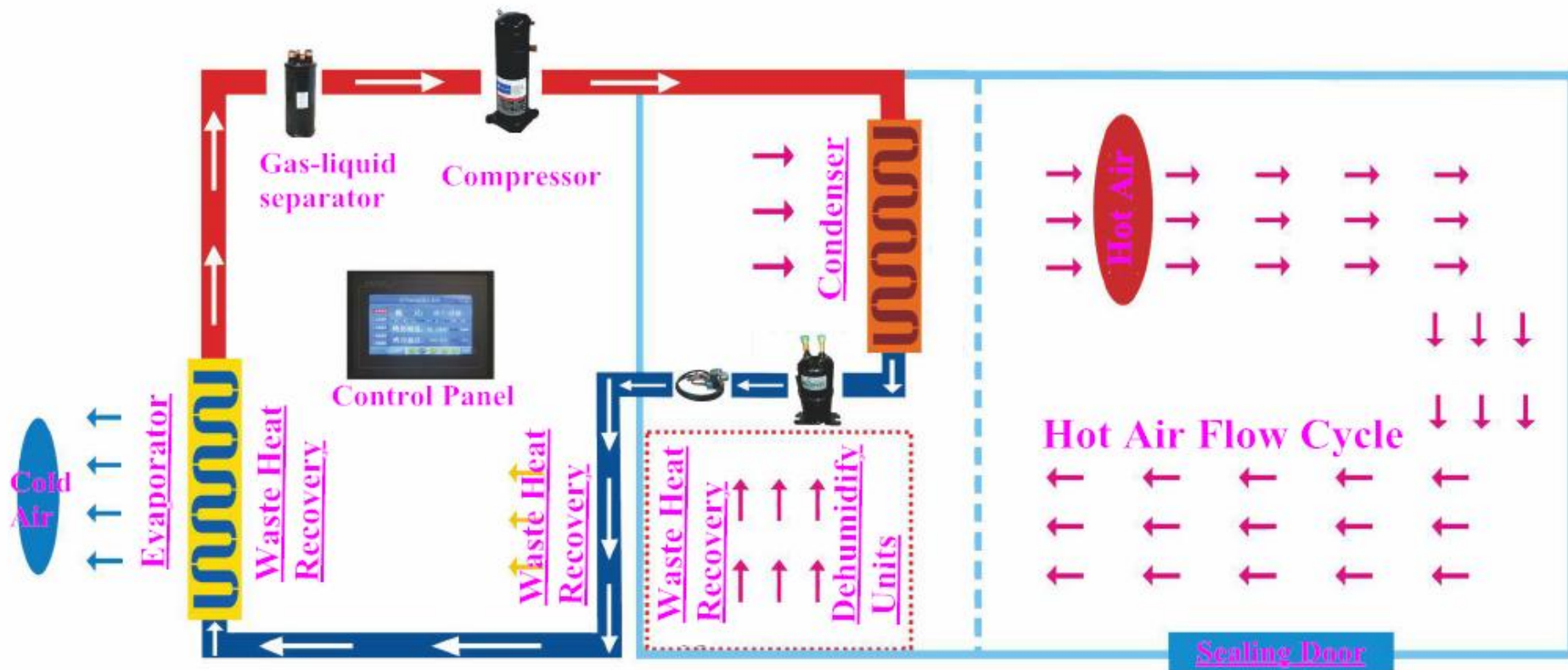

Working Principle

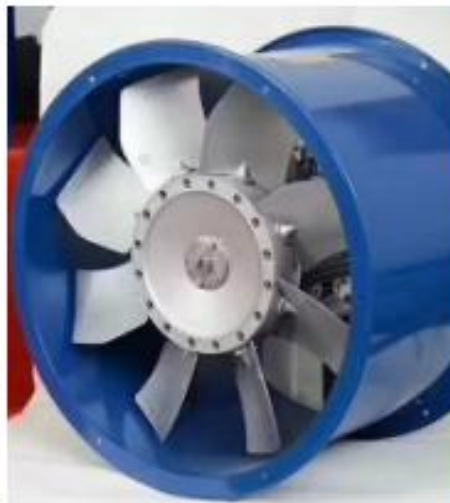
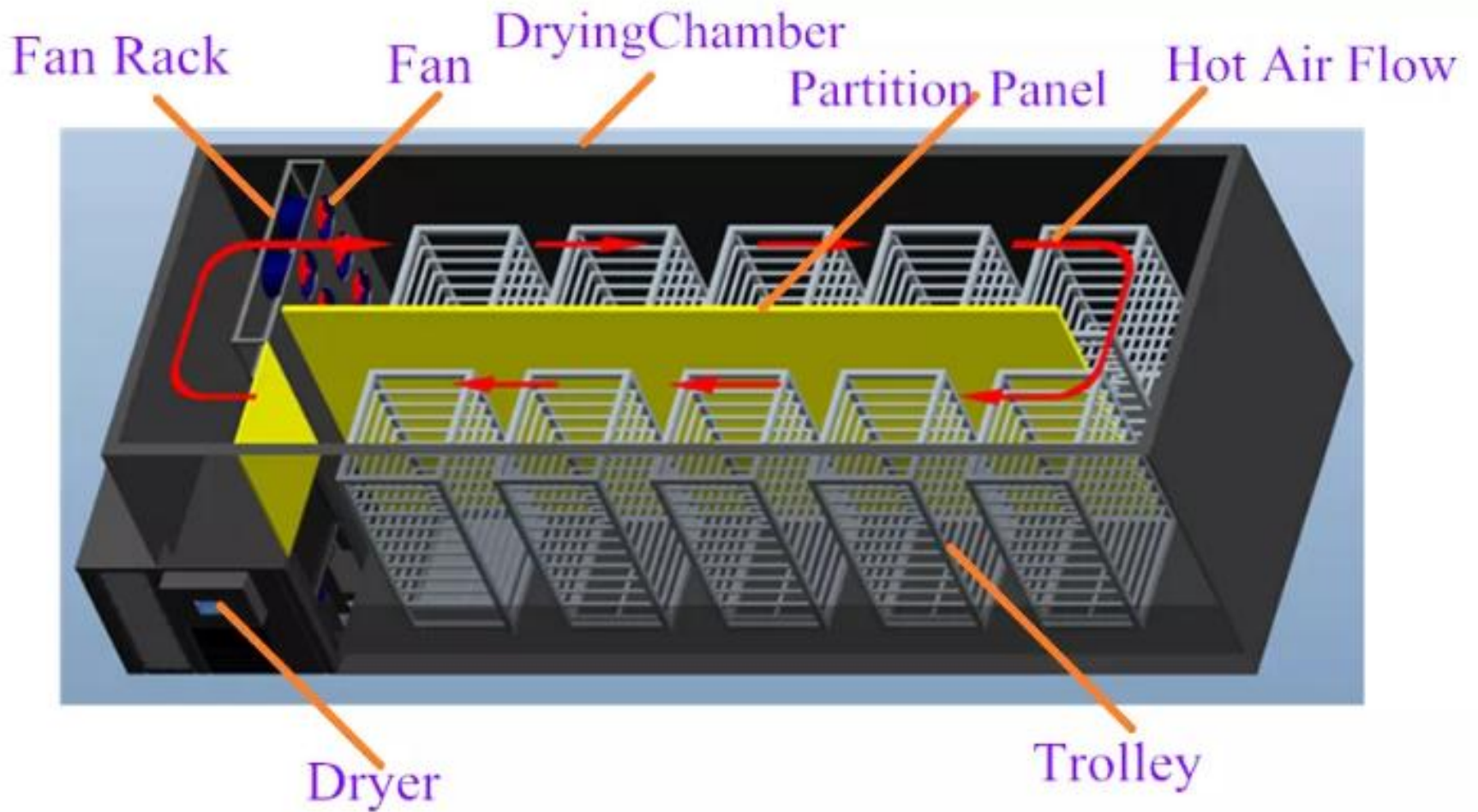







Main Engine

Some materials contain volatile components, during the drying process, the water vapor in the warehouse is cooled by the evaporator and discharged with the condensate water. The condensate water with volatile components is collected, completing the material drying and effective component recovery.

Powerful Compressor

American Copeland compressor is used in the compression system, which has strong performance, and can adapt to long-term stable operation in harsh environment. Multiple safety protection such as over-current protection and phase loss protection is set to effectively ensure the service life of the equipment.



High Stability Electrical Components



The electrical components are Schneider components, equipped with high-performance electronic control chip of six layer printed circuit board, strong anti-electromagnetic interference, intelligent electronic control, automatic adjustment, to ensure the safe and stable operation of the unit.

High Temperature and Humidity Resistance Fan

The circulation system adopts frontal axial flow fan and circulating fan with high temperature and humidity resistance. It has high performance and high air volume, effectively increases air flow, rapid heat exchange and strong dehumidification. The motor is all aluminum copper winding, waterproof and durable.





Automatic Flow Control

The flow control adopts three flower electronic expansion valve and four-way valve, with high reliability which can realize automatic flow regulation under refrigeration and heating conditions, so that the equipment can always maintain efficient operation.

Hydrophilic Aluminum Foil Heat Exchanger

The heat exchanger is made of hydrophilic aluminum foil material, which is corrosion-resistant, mildew proof and odorless. The heat absorption area is larger and the heating efficiency is higher. The noise caused by the condensation water blocking the air flow can be effectively avoided.

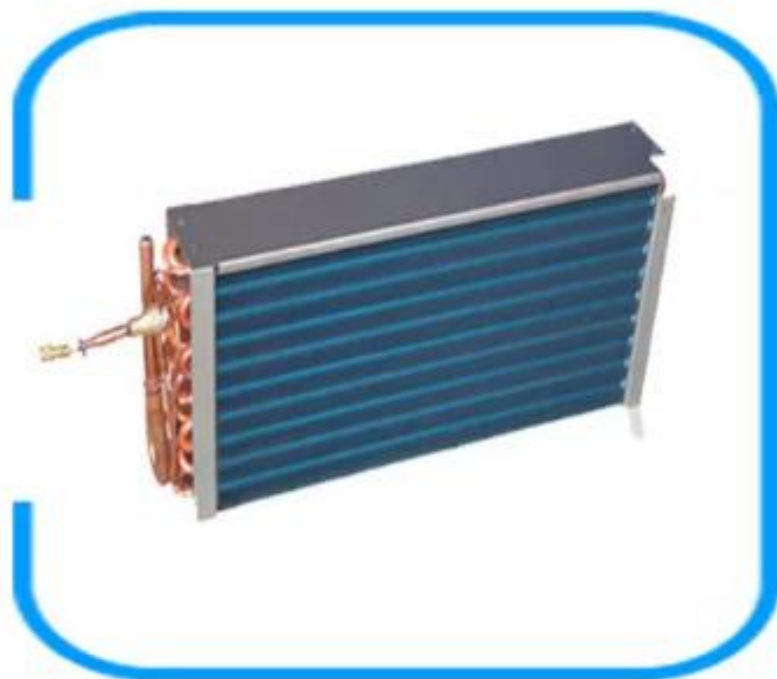







Fish



Fruit



Spice



Tea Leaf



Vegetable



Flower



Meat







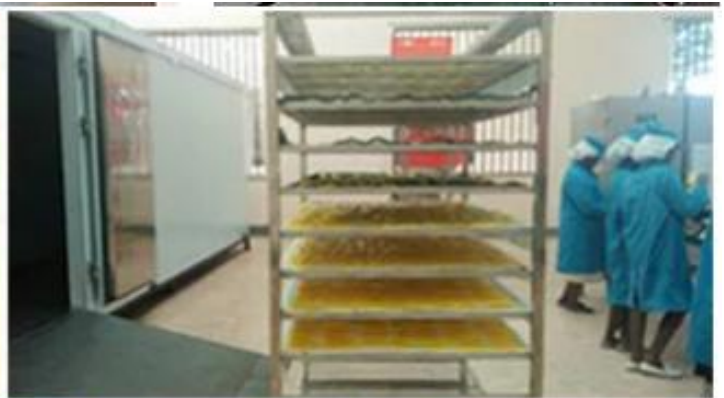



Food-class stainless steel

The grill is made of food grade stainless steel, to maximize food safety.





Quick Support

Technical Details

Model:- Yukti 263. **Drying Chamber Size:-** Width 3.2m* Length 7.2m* Height 2.4m. **Fan Model:-** 250W. **Fan Quantity:-** 12. **Fan power:-** 3KW (0.25KW*12PCS). **Total power:-** 26.7KW Electric Heater On 14.7KW Electric heater off. **Power Supply:-** 380v/3phase /50hz. **Rated Current:-** 29.6a. **Heating Capacity:-** 51.6kw. **Cooling Capacity:-** 35kw. **Dehumidify:-** 60lh. **Max. Temperature:-** 75c. **Working Condition:-** 0.43c. **Electric Shock Protection Grade:-** Class I. **Noise:-** Db(A) \leq 75. **Power Consumption:-** 14.7kw Hours. **Electric Heater:-** 12kw. **Blowing Type:-** Horizontal Blowing 360. **Weight:-** 550kg. **Drying Room Made:-** 2 Sides Coated Cover Pu-Thickness 100 Mm. **Trolley And Trays Made:-** Pure Food Grade Steel. **Trays:-** 120 Units Included You Can Add Up To 200 (Custom As Per Demand) **Trolley:-** 6 You Can Add Up To 8 Unit (Custom As Per Demand). **Per batch capacity:-** 1500-2000kg. **Warranty:-** 1 Years. **Warranty Provider:-** Yuktiraj Pvt Ltd. **Shipping:-** All India Free. **Support:-** Online.

Price:- 2720000 INR + 18% Gst 4,89,600 INR Total Payable 32,09,600 INR.



Read More This Product Visit Below Link:-

<https://www.topsell.in/Industrial-Dehydrator-Dryer-Drying-Machine-Price.php>

इस प्रॉडक्ट अधिक जानकारी के लीये नीचे के लिंक को विजिट करे

<https://www.topsell.in/Industrial-Dehydrator-Dryer-Drying-Machine-Price.php>



YUKTIRAJ PVT LTD

ISO Certified Indian Company

Why us

Yuktiraj Pvt Ltd Is Will Continue With Technical Force, High Quality Product Performance, Reasonable Price, Thoughtful & Efficient Service. Our Company Stresses On The Experience Accumulation And Technology Research. 365 Days Full Support. Honest And Trustable Company. Responsive Staff. We Keep Trust On Quality And Customer Satisfactions. We are India's leading manufacture and import export company.



YUKTIRAJ PVT LTD

ISO Certified Indian Company

*** Company Address ***

Yuktiraj Pvt. Ltd,

Raje Shambhaji Nagar Kinhi Road Bypass Karanja Lad

District: Washim State: Maharashtra Pin: 444105



WhatsApp

9588688034

Thank you always with you



Terms And Conditions :- <https://www.topsell.in/tc>

www.topsell.in